

1&1 Mail&Media

LIBREOFFICE ONLINE ADOPTION INTO 1&1 MAIL & MEDIA ECOSYSTEM



Eduard Ardeleanu
Senior Software Engineer



Agenda

- Why LibreOffice Online?
 - Online Office Editor
 - Online Office Viewer
- Architecture Overview
 - System Solution
 - Deployment – Kubernetes
 - Monitoring – Prometheus / Grafana
- Contributions added by 1&1
- Demo

Why LibreOffice Online ?

Cloud – Allows to View & Edit files

Mail Attachments – Allows to View file attachments and *soon* to Edit file attachments

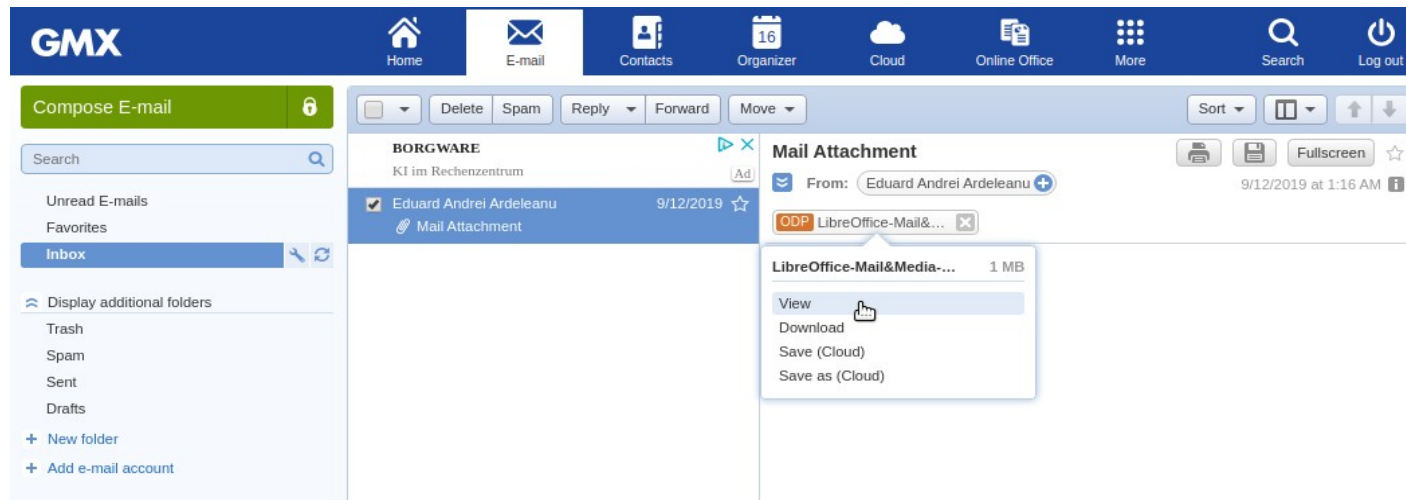
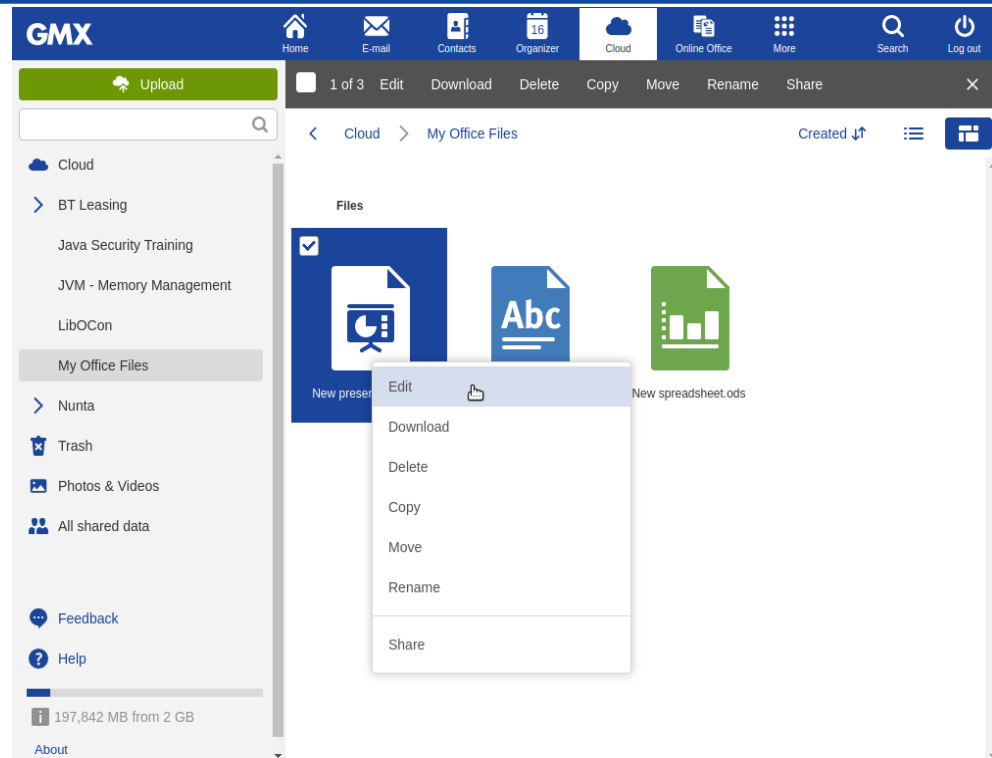

Online Office Editor WEB.DE

Online Office

Start E-Mail Adressbuch Kalender Online-Speicher WEB.DE Club Domains Mobilfunk Musik-Flatrate mehr

Suche Logout

Neues Dokument.odt

Datei Bearbeiten Ansicht Einfügen Format Tabelle Extras Hilfe

Standard Liberation Sans 11 B I U S Aa

Neues Dokument.odt

Datei öffnen

- Aus Online-Speicher
- Hochladen
- Zuletzt verwendet

Feedback Hilfe

Impressum

Suchen: Seite 1 von 1 | 123 Wörter, 753 Zeichen | Einfügen | Standardauswahl | Englisch (USA) | Dokument gespeichert | 100%

LibreOffice Online

What is it?

LibreOffice Online is a server service built from the main LibreOffice project code which provides display and collaborative visual editing of a range of document types. It does not include any form of file system. To be fully functional, it has to be integrated with file access and authentication provision from an underlying stack of software.

For anything more than casual use it also needs to be deployed with due consideration for load balancing and other scaling issues. As such, LibreOffice Online can be considered an enabling technology for the public cloud of IaaS or the private cloud of enterprises and large organizations, when integrated - for example - with an enterprise file sharing or a groupware solution.

Online Office Editor GMX.COM

The screenshot displays the GMX Online Office Editor interface. At the top, there is a navigation bar with icons for Home, E-mail, Contacts, Organizer, Cloud, Online Office, and More. Below this is a menu bar with options like File, Edit, View, Insert, Format, Table, Slide, Tools, and Help. The main workspace shows a LibreOffice presentation slide titled "LIBREOFFICE ONLINE ADOPTION INTO 1&1 MAIL & MEDIA ECOSYSTEM". The slide content includes:

- 1&1 Mail&Media
- LIBREOFFICE ONLINE ADOPTION INTO 1&1 MAIL & MEDIA ECOSYSTEM
- Agenda:
 - Why LibreOffice Online?
 - Cloud
 - Deployment - [Slide 10/20](#)
 - Monitoring - [Presentation 10/20](#)
 - Contributors added by 1&1
 - Done
- Why LibreOffice Online?
 - Mail Architecture
 - Cloud
 - LibreOffice Online
 - LibreOffice Online
- Why LibreOffice Online?
 - LibreOffice Online
 - Mail Architecture
 - LibreOffice Online
- Online Office Editor WEEKEND
- Online Office Editor COURSE

At the bottom of the slide, there is a photo of Eduard Ardeleanu, Senior Software Engineer, and the 1&1 logo. The interface also shows a sidebar with "Open File" options (From the Cloud, Upload, Recently used) and a bottom status bar with "Slide 1 of 20" and "English (USA)".

Online Office Editor - FullScreen -

File Edit View Insert Format Table Slide Tools Help LibreOffice-Mail&Media.odp

Title Slide Liberation Sans 18 B I U S Aa □ ▢ ▣ ▤ ▥ ▦ ▧ ▨ ▩

LIBREOFFICE ONLINE ADOPTION INTO 1&1 MAIL & MEDIA ECOSYSTEM

1&1 Mail&Media

LIBREOFFICE ONLINE ADOPTION INTO 1&1 MAIL & MEDIA ECOSYSTEM

 Eduard Ardeleanu
Senior Software Engineer



Search: Slide 1 of 20 English (USA) Document saved 100%

Online Office Editor mail.com

mail.com

Home E-mail Contacts Organizer File Storage Online Office Premium More

Search Log out

abc

Open File

- From the Cloud
- Upload
- Recently used

Feedback

Help

About us



Welcome to mail.com Online Office!
Create a new file or open an existing document.

Online Office Viewer

The screenshot shows a web-based office viewer interface. At the top, there is a navigation bar with icons for various services: Online-Speicher, Start, E-Mail, Adressbuch, Kalender, Online-Speicher, WEB.DE Club, Domains, Mobilfunk, Musik-Flatrate, and mehr. On the right side of the navigation bar are icons for Suche and Logout. Below the navigation bar, the document title "Neues Dokument.odt" is displayed, along with "Hilfe" and "Schließen x" buttons. The main content area shows a document with the following text:

LibreOffice Conference 2019, Almería, Spain

The 2019 edition will be held in the [city of Almería](#), Spain, from September 10 to September 13, 2019. On September 10 afternoon there will be community meetings, particularly interesting for active contributors and newcomers.

Below the text is a photograph of a public square in Almería, Spain. The square features a large, colorful sign that reads "I love Almería". The sign is made of large, 3D letters, with the "I" being red and the "love" part being a red tomato. The "Almería" part is in white. The square is paved with light-colored tiles and has several palm trees and street lamps. In the background, there is a tall, white monument and a building.

Agenda

- Why LibreOffice Online ?
- Architecture Overview
 - System Solution
 - Deployment – Kubernetes
 - Monitoring – Prometheus / Grafana
- Contributions added by 1&1
- Demo

System Solution

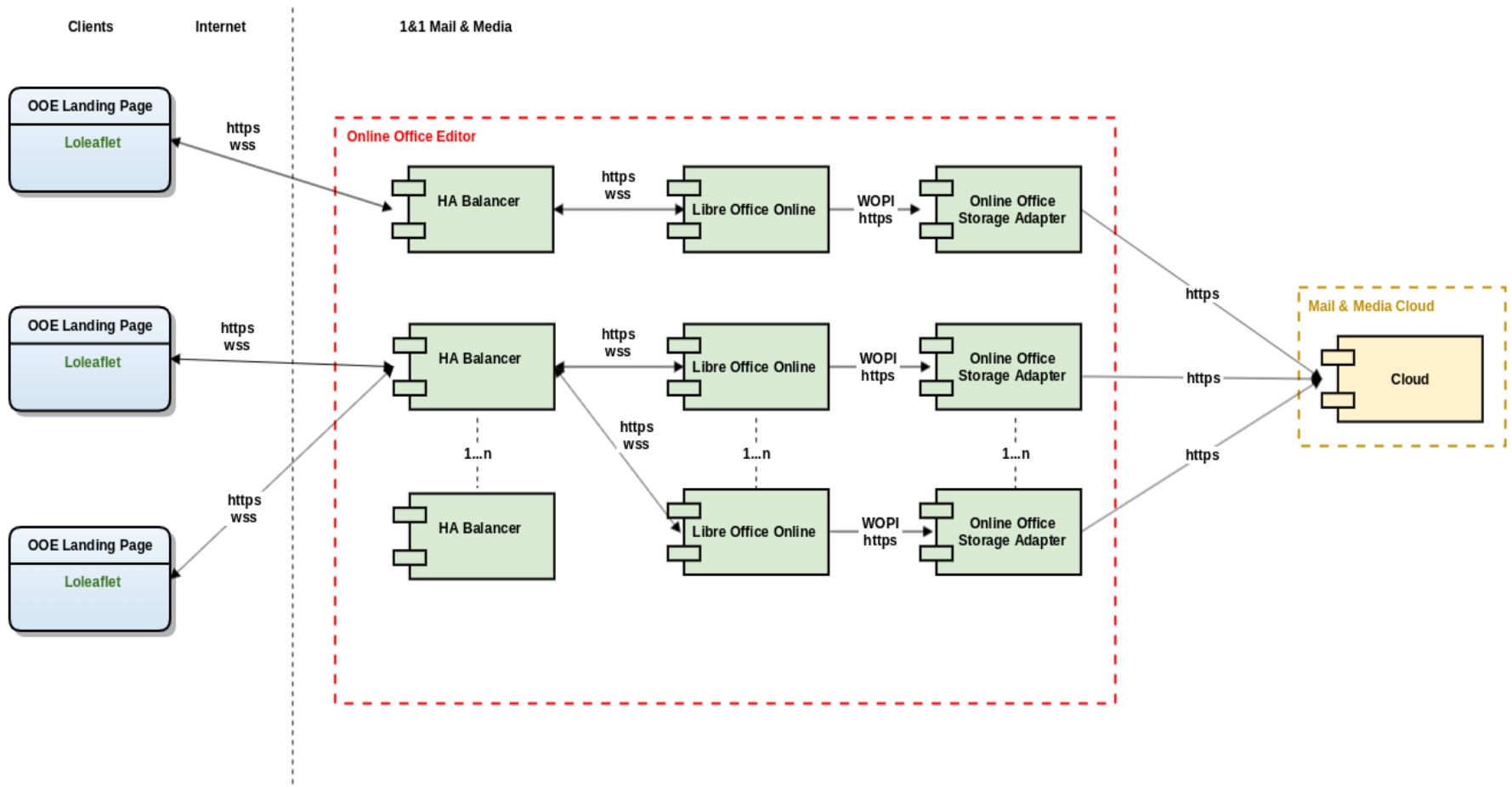

System Solution

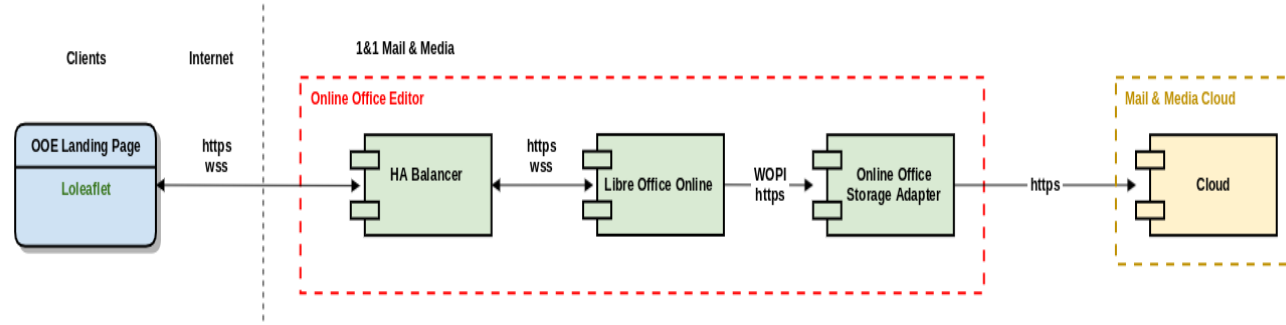

OOE LANDING PAGE

- Create new documents; blank templates – text, spreadsheet, presentation
- Browse through your Cloud documents to open them in edit mode
- Upload new documents in your Cloud and open them in edit mode
- Browse through your recently used documents from Cloud

HA BALANCER

- Acts as a middleware between Clients and LibreOffice Online
- Responsible for: authentication, session management and load-balancing

OOE STORAGE ADAPTER

- Facilitates communication between LibreOffice Online and Mail & Media Cloud
- Implements WOPI REST Specifications

All Online Office Editor modules are scaled with **Kubernetes**

Deployment - Kubernetes



Package manager for Kubernetes

- **Helm** uses a packaging format called **charts**
- A **chart** is a collection of files that describe a related set of **Kubernetes resources** – **Helm Hub** -

```

libreoffice-online/
  Chart.yaml           # YAML file containing information about the chart
  LICENSE              # OPTIONAL: A plain text file containing the license for the chart
  README.md           # OPTIONAL: A human-readable README file
  requirements.yaml    # OPTIONAL: A YAML file listing dependencies for the chart
  values.yaml         # The default configuration values for this chart
  Charts/             # A directory containing any charts upon which this chart depends
  Templates/          # A directory of templates that, when combined with values,
                       # will generate valid Kubernetes manifest files

```

Kubernetes – Horizontal Pod Autoscaler

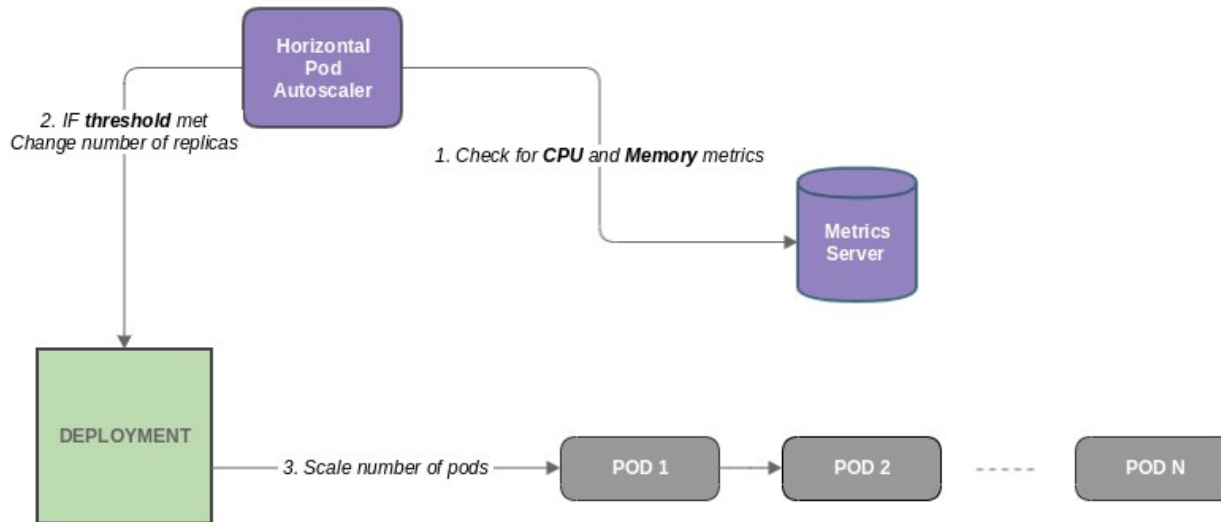

```

Metrics:                                     ( current / target )
  resource memory on pods (as a percentage of request): 40% (1294229504) / 70%
  resource cpu on pods (as a percentage of request):    5% (58m) / 70%
Min replicas:                                       1
Max replicas:                                       3
Deployment pods:                                    2 current / 2 desired

```

Automatically scales the number of pods based on **CPU / Memory** usage

Monitoring – Prometheus / Grafana

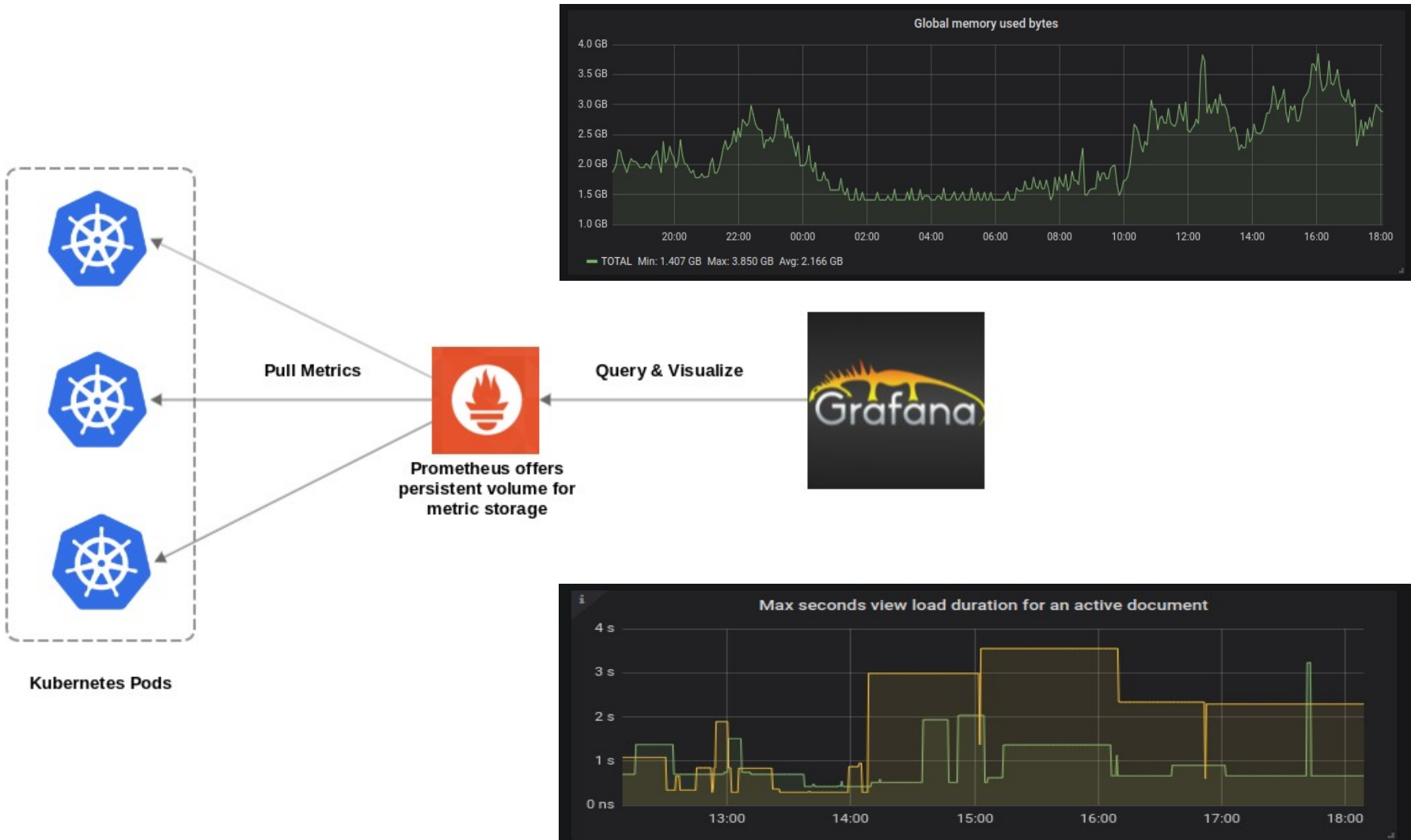

Agenda

- Why LibreOffice Online ?
- Architecture overview
- Contributions added by 1&1
- Demo

Contributions added by 1&1

Coming soon ...

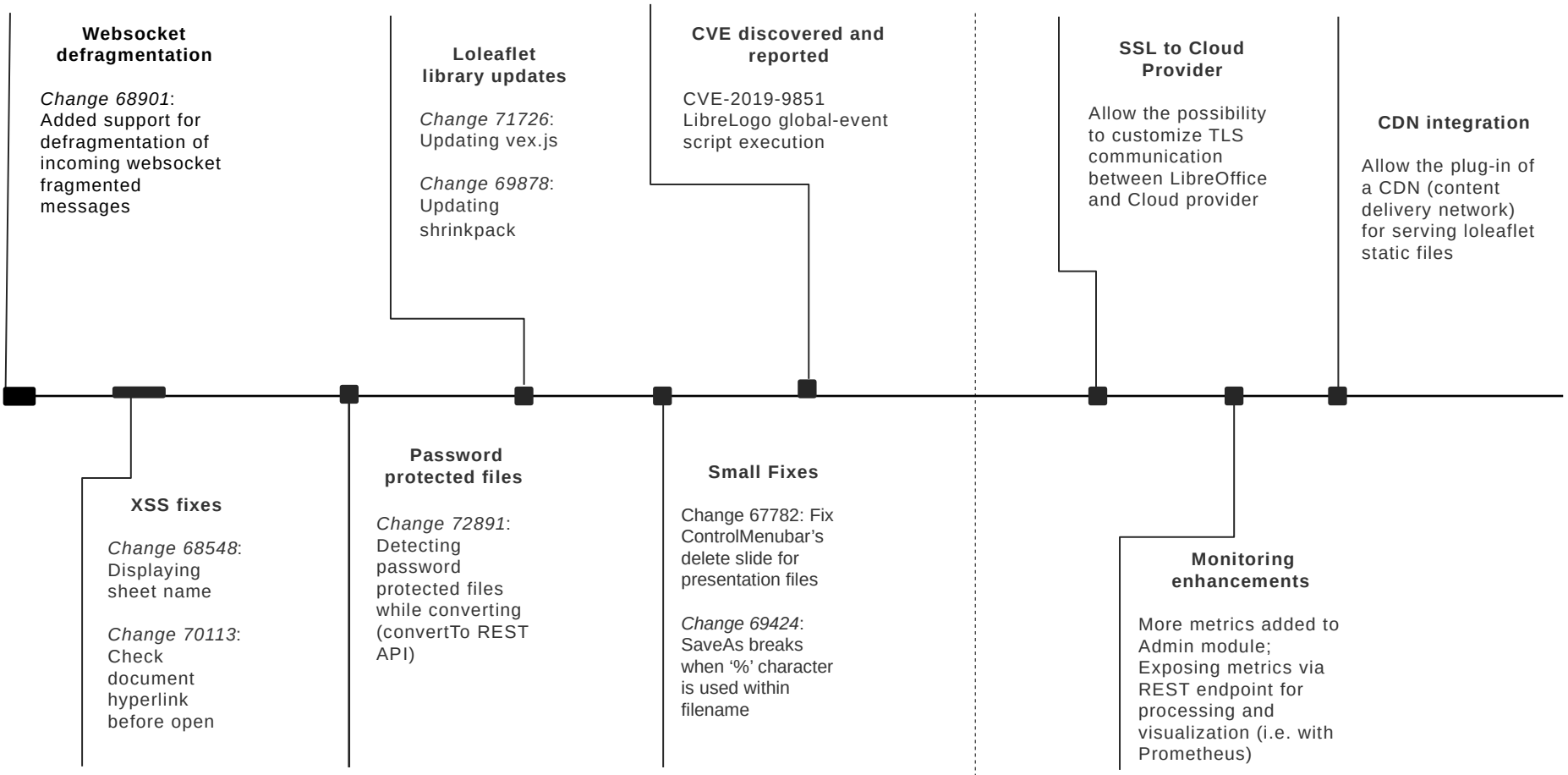

Agenda

- Why LibreOffice Online ?
- Architecture overview
- Contributions added by 1&1
- Demo

Thank you!



Online Office